

# UNIT 6 - REFRIGERATION AND AIR CONDITIONING SYSTEM

## REFRIGERATION

### Need for refrigeration

- In hotels and households, food items, both cooked and uncooked, can be preserved for a long time in low temperatures.
- Storage of fruits and vegetables makes it possible to add fresh salads to the menu all year round.
- Storage of fish, meat and other perishables items safely for longer periods is possible due to refrigeration.
- Seasonal food items can be bought from the market in bulk quantity at relatively cheaper price, stored in refrigerated conditions and later used during off season.
- Cooling of desserts and drinks.

### What is refrigeration? And useful definitions

Refrigeration is the science of producing and maintaining a temperature condition in a closed space lower than the surrounding ambience by removing heat from the space and transferring that heat to another space or substance.

### TERMS USED IN REFRIGERATION:

- **REFRIGERANT** – It is the substance used for heat transfer in a refrigeration system. It takes up heat from inside the refrigerator cabinet and releases it to outside atmosphere.
- **SENSIBLE HEAT** – The heat which is used to raise or lower the temperature of a substance.
- **LATENT HEAT** – Latent heat is the energy absorbed or released when a substance changes its physical state. Latent heat is absorbed upon evaporation, and released upon condensation to liquid (as in clouds).
- **EVAPORATION** – It is the process of a substance in a liquid state changing to a gaseous state due to an increase in temperature and/or pressure.
- **CONDENSATION** - It is the change of the physical state of matter from gas phase into liquid phase, and is the reverse of evaporation.
- **ONE TON OF REFRIGERATION** – It means cooling by extracting heat at the rate of 50Kcal/minute or 3000 Kcal/hr.

### Types of refrigerants and usage

APPLICATION	REFRIGERANTS
Refrigerator	R <sub>12</sub> , R <sub>22</sub> (CFC)
Food Freezers	R <sub>12</sub> , R <sub>22</sub> , R <sub>502</sub> (HCFC in gaseous state)
Air Conditioning	R <sub>12</sub>
Frozen Food Delivery System	R <sub>22</sub> , Dry Ice (R <sub>744</sub> )
Ice Plants	Solid Carbon Dioxide (R <sub>744</sub> ), Ammonia (R <sub>717</sub> )

### Desirable properties of refrigerants

- It should be non poisonous and non irritant.
- It should be non flammable.
- It should be chemically stable.
- It should be non corrosive and should not react with the parts / components of the system.
- It should have no objectionable odour or smell.
- It should be easily and reliably detectable in case of leakage.
- Its LH of vapourisation should be high so that quantity of high refrigerant can be minimized.
- Its cost should be low.
- It should be easily available.

## REFRIGERATION PROCESS

The main components of a refrigeration process are:

1. Evaporator
2. Compressor
3. Condenser
4. Expansion Valve

**EVAPORATOR:** In the evaporator the Refrigerant absorbs the heat from the object to be cooled and itself gets heated up. The heat absorbed is the latent heat of vapourisation of the liquid refrigerant and therefore the refrigerant undergoes a change of state i.e. from liquid to vapours without any change in temperature. The vapour refrigerant then returns to the compressor.

**COMPRESSOR:** The vapour refrigerant is compressed at a very high pressure and temperature. It then passes through the condenser coil.

**CONDENSER:** While passing through the condenser the refrigerant rejects heat either to air or to surrounding water which gets heated up. The refrigerant condenses to cold liquid state but at high pressure. This high pressure colder refrigerant then passes through the expansion valve.

**EXPANSION VALVE:** The expansion valve cools down the refrigerant to a low temperature and also reduces the pressure.

It can be adjusted to control the temperature and pressure to which the refrigerant goes to the evaporator.

The cool refrigerant is now ready to absorb heat from the hot objects while passes through the evaporator.

\* Efficiency of Refrigeration System is expressed as Coefficient of Performance (COP) and is defined as the ratio of refrigeration effect produced to the mechanical work done.

## REFRIGERATION CYCLE

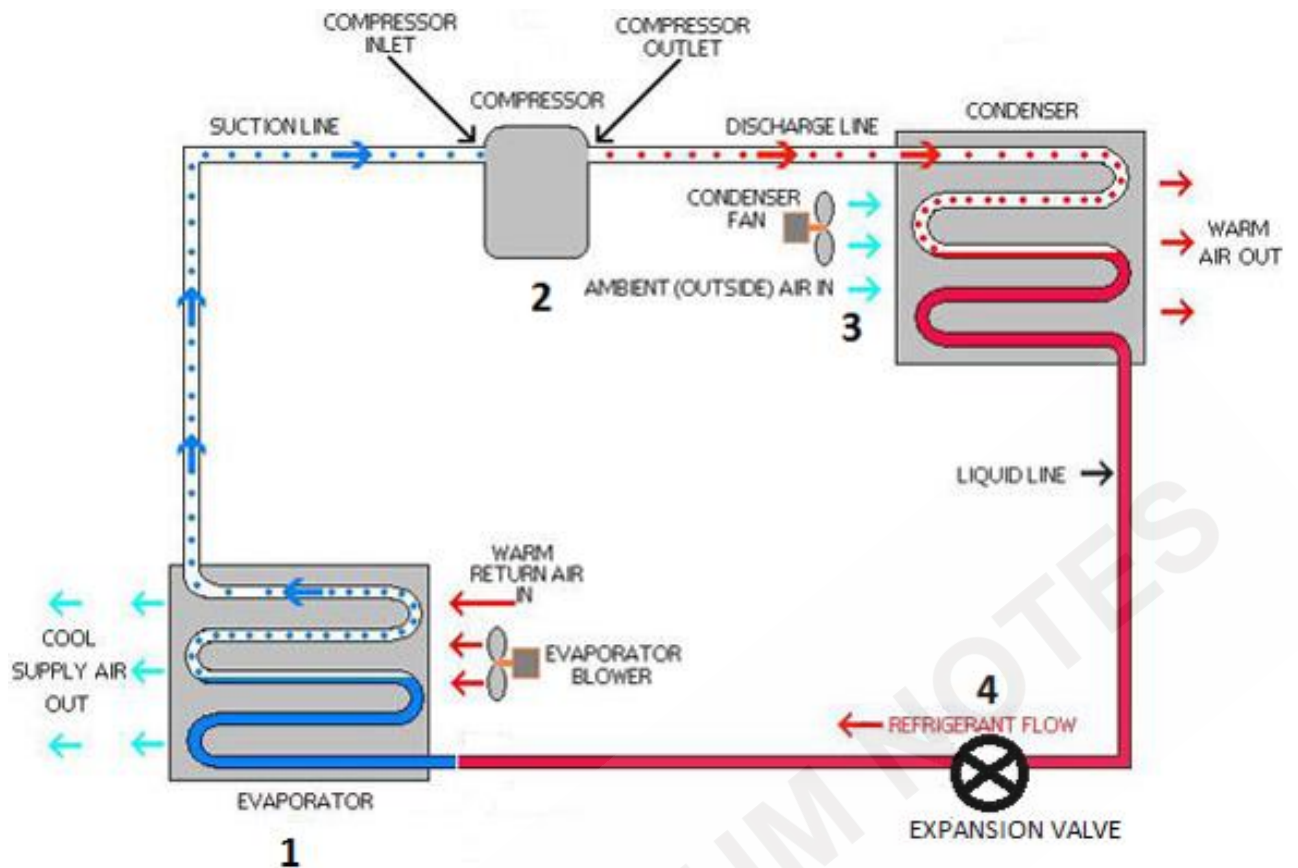

To avoid continuous running of electric motor (motor required to run the compressor) and unnecessary work of compression, thermostatic control is used which senses the set interior temperature and stops the motor from running and when the temperature rises again, the motor restarts and the Compressor starts working again.

Compressor is the most expensive part of the refrigeration cycle and its repair is difficult. An inefficient or defective compressor is generally replaced with a new one.

## Vapour compression refrigeration system

**Part 1: Compression:** In this stage, the refrigerant enters the compressor as a gas under low pressure and having a low temperature. Then, the refrigerant is compressed, so the fluid leaves the compressor under high pressure and with a high temperature.

**Part 2: Condensation:** The high pressure, high temperature gas releases heat energy and condenses inside the "condenser" portion of the system. The condenser is in contact with the hot reservoir of the refrigeration system. (The gas releases heat into the hot reservoir because of the external work added to the gas.) The refrigerant leaves as a high pressure liquid.  
Vapour compression refrigeration system

**Part 3: Throttling or Expansion Valve :** The liquid refrigerant is pushed through a throttling valve, which causes it to expand. As a result, the refrigerant now has low pressure and lower temperature, while still in the liquid phase. (The throttling valve can be either a thin slit or some sort of plug with holes in it. When the refrigerant is forced through the throttle, its pressure is reduced, causing the liquid to expand.)

**Part 4: Evaporation:** The low pressure, low temperature refrigerant enters the evaporator, which is in contact with the cold reservoir. Because a low pressure is maintained, the refrigerant is able to boil at a low temperature. So, the liquid absorbs heat from the cold reservoir and evaporates. The

refrigerant leaves the evaporator as a low temperature, low pressure gas and is taken into the compressor again, back at the beginning of the cycle.

## Vapour compression refrigeration system

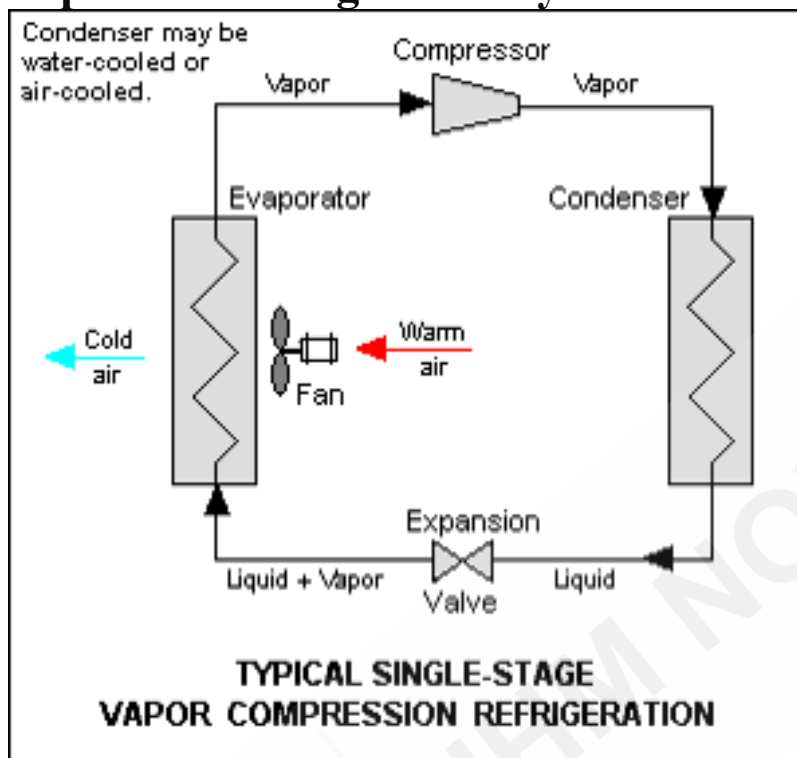

## Vapour absorption refrigeration cycle

**Part 1. Absorption:** Low pressure vapour of ammonia from evaporator is absorbed in a weak solution of aqua (liquid) ammonia in the absorber and thus gets converted into a strong solution. Strong solution of water and ammonia is pumped into a generator, while a weak solution returns to the absorber from the generator.

**Part 2. Generation of High Pressure vapour:** Strong solution pumped into the generator from the absorber is heated inside the generator. Ammonia separates in the form of vapour ammonia from the solution as the absorption of ammonia in water is at a lesser higher temperature. The weak solution is sent back to the absorber. The high pressure, high temperature, ammonia vapours are then led to the condenser.

**Part 3. Condensation:** High pressure hot ammonia vapours from the generator, are condensed in the condenser and high pressure liquid ammonia so formed is stored in the receiver.

**Part 4. Expansion:** High pressure liquid ammonia on its way to the evaporator passes through the expansion valve which reduces its pressure and temperature.

**Part 5. Evaporation:** The low pressure liquid refrigerant from the expansion valve, while passing through the evaporator, absorbs latent heat and converts it into low pressure vapour ammonia. Thus it produces a refrigerating effect in the space around the evaporator. From the evaporator the low pressure ammonia goes to the absorber and this way it completes one cycle of working.

## Vapour absorption refrigeration cycle

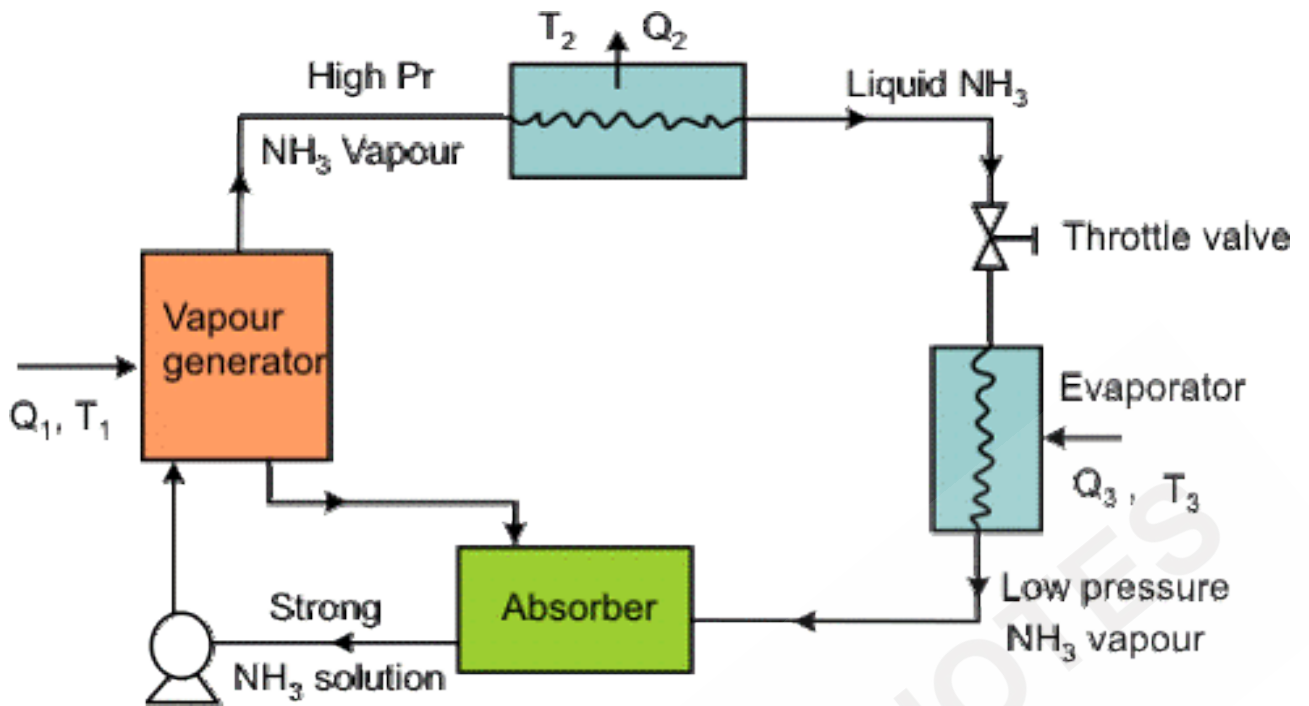

## TYPES OF REFRIGERATING UNITS IN HOTEL INDUSTRY

The usual categories of refrigerating units employed in the hotel industry are:

- Reach – in Units
- Counter – top or table – top Units
- Walk – in Units
- Special – purpose Units

Each of the above mentioned units can have both cooler and freezer sections in them. Some refrigerators are now divided into four zones to store different types of food. They are as follows:

Subzero (up to  $-18$  degree Celsius) - Freezer Section

0 degree Celsius - Meat preservation Section

5 degree Celsius - Refrigerator

10 degree Celsius - Vegetables Section

### Reach – in refrigerators

Coolers & Freezers – Capacities of such units are usually expressed in terms of the internal space volume (cubic metre) or in mass (Kg) of material being stored in it.

Typical interior temperature range for cooler should be 4.4 degree Celsius to 7 degree Celsius and for a freezer should be  $-15$  degree Celsius to  $-23$  degree Celsius.



## Counter top units

Small counter top refrigerators are frequently used to facilitate service. They are usually coolers and have features similar to those of reach-in coolers but of much smaller size usually up to a size of 100 litres only.



## Walk – in refrigeration system

As the name suggests, food operators can directly move into such units. They are much bigger in size and height than walk – in refrigerators. A typical size would be 4 X 5 X 3 m, or even more, or as less as having a floor area of 2 sq. m.. They are normally custom built.



## Special purpose units

**Ice Cream Conservator and frozen food conservator:** They are usually “well type” and open vertically through a lid. This minimizes heat loss as cool and heavy air inside cannot escape upward. They are usually maintained at temperatures between -23 to -18 degree Celsius.



**Wet Fish Cabinets:** They contain deep galvanized drawers in which fish can be embedded in ice. They keep moist storage conditions necessary for maintaining the quality of fish. They are usually maintained at temperatures between 0 to -2 degree Celsius.



## Special purpose units

**Display Cabinets:** In many hotels, there is a refrigerated display cabinet kept in the dining for the customers to choose varieties of meats for grilling. They are also used to display bakery products and desserts.

**Bottle Coolers:** They are used in dining and are usually in bars. They are constructed in two ways. One is open refrigerated through type and the other is glass front cabinet type with hinged doors or sliding doors.

**Ice makers:** Modern ice making machines need only to be connected to a cold water supply line. Water flows over a refrigerated plate and gets converted into a slab of ice. This slab of ice passes over a wire net which is electrically heated and the slab melts along the wire mesh and falls through the square holes as separate small cubes of ice.



## CARE AND MAINTENANCE OF REFRIGERATING UNITS

Regular cleaning and maintenance not only makes your equipment work more efficiently, but it also helps it last longer. When parts are worn and dirty, the unit runs more frequently causing more wear and tear on the parts. Eventually, the unit breaks down for good long before it should have.

Preventing these issues is simpler than you think. Call in a qualified refrigeration service company at least twice a year and up to once a month, depending on the load and usage of your equipment, to do the following tasks:

- Clean evaporator and condenser coils
- Check lines for condensation
- Clean fan blades and inspect the fan motor
- Check integrity of insulation
- Check for air leaks through cracks, holes, and worn parts like gaskets and seals
- Lubricate door hinges and handles
- Check for loose electrical connections
- Clear drain lines of debris
- Check temperature and defrost settings and calibrate thermometers
- Check filters on ice makers
- Thoroughly clean all ice maker components

## AIR CONDITIONING SYSTEM

### What is Air Conditioning?

Any type of conditioning of air which includes circulating air in a room, filtering air, cooling or heating air, humidifying or dehumidifying air.

Complete air conditioning would mean all such processes being carried on air.

Refrigeration plant is necessary for such air – conditioning system.



## Terminologies used in Air Conditioning

- **Psychrometry** – The study and measurement of the properties of air and water vapour mixture is known as psychrometry.
- **Dry Air** – Atmospheric air consisting of a mixture of gases excluding its water vapour content is known as dry air.
- **Moisture** – The water vapour contained in air is called moisture.
- **Moist Air** – Atmospheric air along with gases and water vapour is known as moist air.
- **Unsaturated Air** – The moist air which does not contain the maximum amount of water vapour that it can hold at a given temperature is known as unsaturated air.
- **Saturated Air** – The moist air which contains the maximum amount of water vapour that it can hold at a given temperature, is known as saturated air.
- **Dry Bulb Temperature (DBT)** – The reading of temperature of air given by an ordinary mercury thermometer, having its bulb dry and not under the sun or other heat radiating objects.
- **Dew Point Temperature (DPT)** – At atmospheric temperature atmospheric air always contains water in form of vapours. If this air is cooled down, the water vapour is turned into water droplets. This temperature at which the water vapours turns into water droplets is called dew point temperature.
- **Wet Bulb Temperature (WBT)** – Temperature of air indicated by a mercury thermometer whose bulb is covered by a piece of wet muslin is known as wet bulb temperature.
- **Specific Humidity (SH)** - It is defined as the total quantity of water vapour in the moist air.
- **Relative Humidity (RH)** – it is defined as the ratio of actual moist air content of a given volume at a particular temperature to the maximum amount of water vapour if the air is saturated at the same temperature.

## PRINCIPLES OF AIR-CONDITIONING

The goal is to keep it more comfortable inside the house than it is outside.

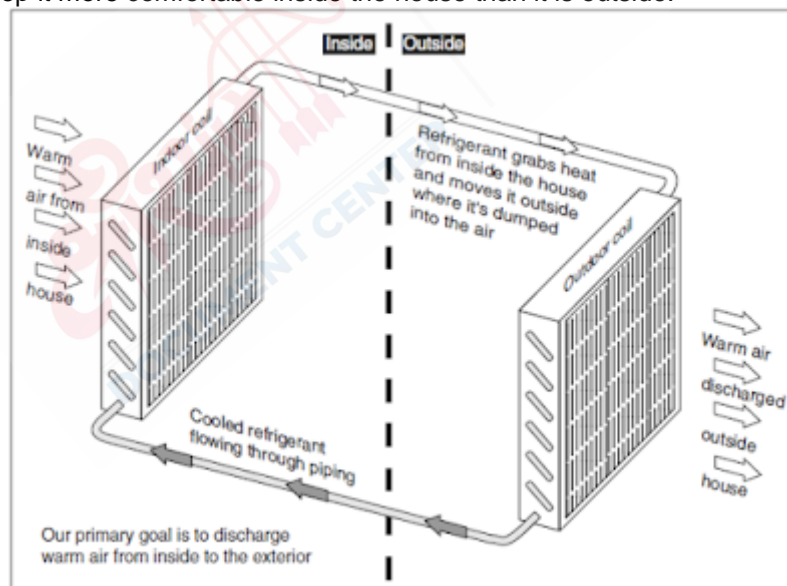

## Types of Air Conditioning Plants

- Centralized air – conditioning System

### Unit air Conditioners

- Window type units
- Split type units

### Centralised Air Conditioning Plant

The central air conditioning plants or the systems are used when large buildings, hotels, theaters, airports, shopping malls etc. are to be air conditioned completely.

The air conditioning system operates essentially in a closed cycle.

Return air from different spaces in the property such as lodging rooms, dining areas, stores, banquet halls, kitchen etc. comes back through the return duct drawn by what is known as an extraction fan or exhauster.

This return air although a little stale is still cold/hot and relatively free from dirt and other contaminants present in fresh air.

Instead of exhausting the entire return gas out and sucking in fresh air only, it is returned to the circuit to minimize energy requirement for cooling/heating and filtration.

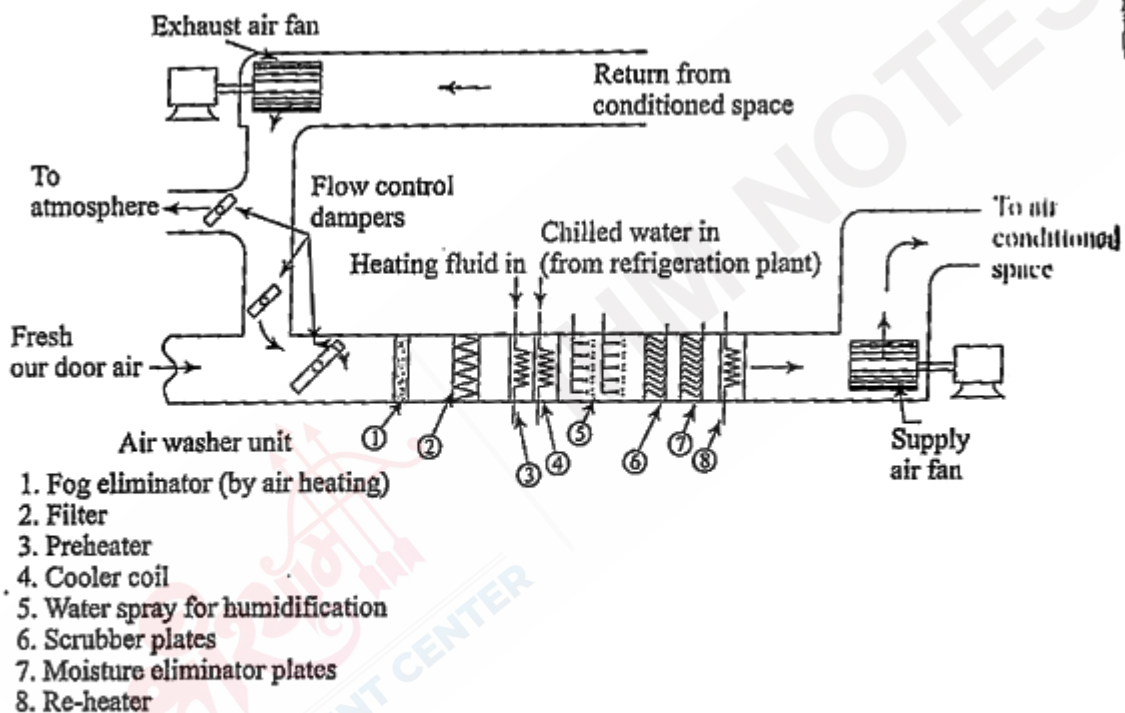

Fig. 11.9 Central ventilation system with complete air-conditioning control

## Components of Centralised Air Conditioning Plant

1. FRESH AIR INLET – It admits fresh air through a louver/grille situated on an outside wall very much away from the kitchen, boiler house and water closet (WC) outlets.
2. FILTERS – It is employed to arrest suspended particulate matter such as dirt and dust from inlet air.
3. AIR WASHERS – This is the air – conditioning section which comprises of the pre-heater coil, refrigerating coil and banks of water sprays. The functions of air washers are to control humidity and clean air.

4. SCRUBBER PLATES – These are a series of zigzag plates with a stream of water running down them and are used to catch the dirt-laden water droplets coming out from the water spray section in the air washer.
5. WATER ELIMINATOR PLATES – These are a series of dry zigzag plates to remove any remaining free moisture in the air stream.
6. MIST ELIMINATOR – It is a metallic / non-metallic bed through which air is flown upwards. Fine mist is trapped in the bed and fall down as they coalesce (combine) to bigger size.
7. AIR HEATER - This is composed of heating coils to bring the air up to the desirable room temperature, if necessary.
8. INLET FAN – It is a fan for drawing air through the inlet, ducting and forcing it into the various spaces in the building.
9. FRESH AIR INLET/LOUVERS – They are fitted in the inlet of the fresh air for uniform entry of fresh air and hence smooth mixing with return air before entry to the air – conditioning section.
10. ROOM INLET GRILLES – One or more grilles in each room for the controlled inflow of air.
11. ROOM EXTRACTION GRILLES – One or more grilles in each room for the outflow of air. One to discharge outside into the atmosphere and another leading back to the AC plant inlet for the re-circulation.
12. EXTRACTION FAN – It is the fan for extracting air in the return path of the air ducting coming back from rooms and spaces.
13. CENTRAL EXTRACTION DAMPER – In case where complete central control is exercised a part of the return air from all spaces is discharged to the atmosphere through a control damper valve in the delivery side of the extractor fan.
14. DUCTING – Ducting is a term used to denote the passage for flow of air from the AC plant through various passages in the building opening into the closed space to be cooled and return to the inlet ducting in the AC plant. This also includes the ducting for exhaust to atmosphere.

## Unit Air Conditioners – Window Type AC

- This is a completely self contained unit with the compressor, condenser, evaporator, refrigerant piping and air filter all assembled in a very compact manner.
- The window AC is usually 0.5 to 5 tons in capacity.
- Latest practice is to use sealed type compressor units so that possibility of leakage of refrigerant is eliminated.
- There is provision to control the fresh air intake.
- It is easy to install, operate and maintain.
- Its running cost is high.
- It requires at least one wall of the room free and open to atmosphere, so that the air is discharged in the open.

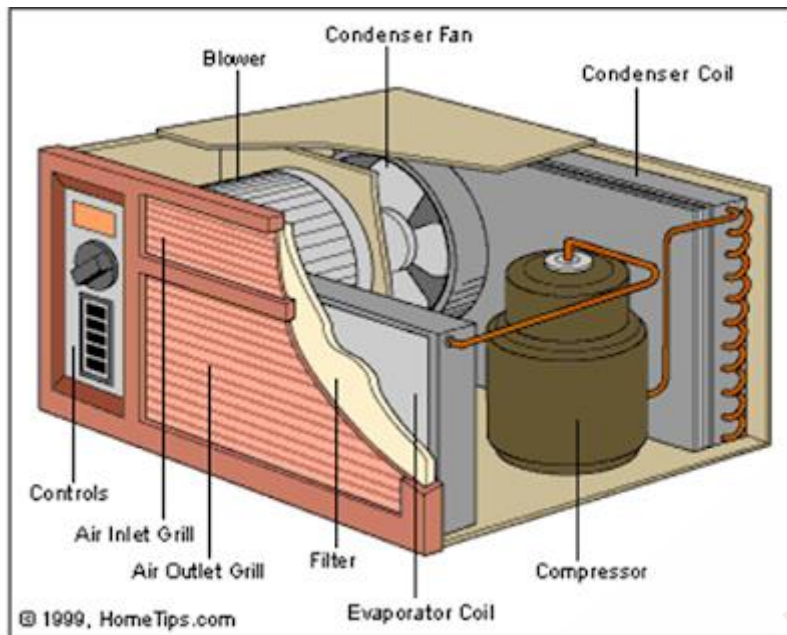

## Unit Air Conditioners – Split Type AC

In this system, the cold side of the unit (such as expansion valve, evaporator coil) is physically separated from the hot side (compressor, condenser).

The refrigerant flows through a long pipeline connecting the hot side and the cold side.

The cold part inside the room and the hot part outside the building.

The main advantages of split type air conditioners are:

Low cost for relatively larger size units

Absence of noise as the compressor is placed outside the building.

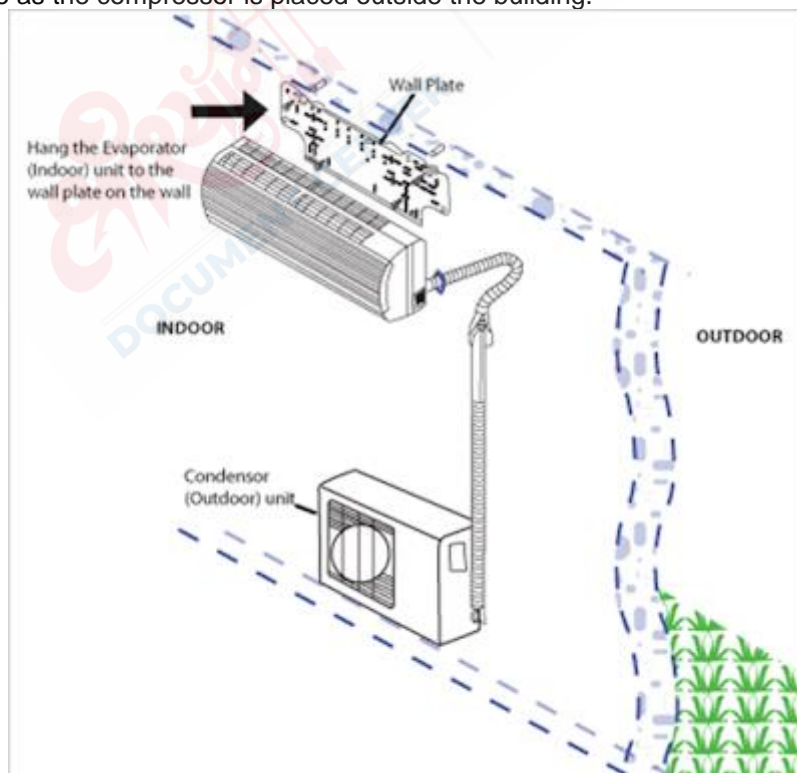

## Building Transport System

Most multi storied hotels have many floors above the ground floor and also one/two floors below the ground floor.

Hence appropriate and efficient building transport systems are not only important but necessary also for operation.

The systems should be a mix of manual and automatic operations.

There are two types of building transport system namely Vertical Transport System and Horizontal Transport System.

## Vertical Transport System

- Stairs
- Elevators / Lifts
- Escalators (Moving Stairs)
- Gravity Chutes (for goods)

### Stairs

This is the most common and essential for vertical movement of people and goods.

It is also mandatory as it is an escape route in case of fire in buildings.

In case of power failure, lifts do not operate and hence stair case is the only alternative for vertical movement.

It must be fire proof so that guests can safely exit to upper and lower building floors.

Provision of hand rails and non-slip steps are recommended for safety purpose.

### Elevators

An elevator is a transportation device used to transport people and goods vertically.

Elevators are generally automatic safety units for up and down transport purpose.

It consists of a platform travelling in vertical guides in a shaft with hoisting and lowering mechanism and a source of power.

The enclosure moving up and down in the guides is known as car.

There are two types of lift systems.

**Cable elevators** – They are more common because they are fast, smooth and quite.

**Hydraulic elevators** - are elevators which are powered by a piston that travels inside a cylinder. An electric motor pumps hydraulic oil into the cylinder to move the piston. The piston smoothly lifts the elevator cab/car. They are used when the number of floors to be serviced is less.

The elevators require regular inspection and maintenance and generally have a life of 20 years.

### Escalators

The term escalator is a combination of elevator and “scala” the latin word for steps.

Escalators are the moving step type lifts operating at constant speed between two levels in an inclined course for moving large number of people in a short time.

It consists of a staircase whose steps move up and down on tracks which keep them horizontal.

Most escalators also have a moving handrail which approximately keeps pace with the movement of the steps.

The direction of movement (up and down) can be permanently the same or can be controlled by operators according to the requirement.

Generally two units are required side-by-side at each level, one moving upward and the other downward.

### Gravity Chutes

Gravity chutes are used by hotels for transporting soiled linen, garbage and waste from different floors of the hotel to an outlet point (generally kept on the ground floor).

It is an efficient system as minimum power is involved in operating it.

Gravity chutes save workers motion, time and increase their productivity.

## Horizontal Transport System

- Conveyor belts (moving sidewalk, moving walk way or traveller)
- Electric cars
- Manual trolley for transportation of luggage.

### Travellers (Moving pavements)

Travellers also known as horizontal moving sidewalks, moving walkways is a slow speed conveyor belt to transport people, they can walk along or stand on it.

They are often installed in pairs, for movement in opposite direction.

Travellers may be used when there is substantial distance between the hotel entry point and the reception point.

### Electric Cars

Electric car is an electrically operated open car with 6 to 8 seats.

This is an alternative to travellers and particularly very useful for disabled persons.

### Manual Trolley

Manual trolley is used for transportation of luggage of guest.

